

FEATURES

Very low voltage noise 2.8 nV/ $\sqrt{\text{Hz}}$ @ 1 kHz
Rail-to-rail output swing
Low input bias current: 2 nA maximum
Very low offset voltage: 12 μV typical
Low input offset drift: 0.6 $\mu\text{V}/^\circ\text{C}$ maximum
Very high gain: 120 dB
Wide bandwidth: 10 MHz typical
 $\pm 5\text{ V}$ to $\pm 18\text{ V}$ operation

APPLICATIONS

Precision instrumentation
PLL filters
Laser diode control loops
Strain gage amplifiers
Medical instrumentation
Thermocouple amplifiers

GENERAL DESCRIPTION

The AD8676 precision operational amplifier offers ultralow offset, drift, and voltage noise combined with very low input bias currents over the full operating temperature range. The AD8676 is a precision, wide bandwidth op amp featuring rail-to-rail output swings and very low noise. Operation is fully specified from $\pm 5\text{ V}$ to $\pm 15\text{ V}$.

The AD8676 features a rail-to-rail output like that of the OP184, but with wide bandwidth and even lower voltage noise, combined with the precision and low power consumption like that of the industry-standard OP07 amplifier. Unlike other low noise, rail-to-rail op amps, the AD8676 has very low input bias current and low input current noise.

With typical offset voltage of only 12 μV , offset drift of 0.2 $\mu\text{V}/^\circ\text{C}$, and noise of only 0.10 μV p-p (0.1 Hz to 10 Hz), the AD8676 is perfectly suited for applications where large error sources cannot be tolerated. Precision instrumentation, PLL and other precision filter circuits, position and pressure sensors, medical

instrumentation, and strain gage amplifiers benefit greatly from the very low noise, low input bias current, and wide bandwidth. Many systems can take advantage of the low noise, dc precision, and rail-to-rail output swing provided by the AD8676 to maximize SNR and dynamic range.

The smaller packages and low power consumption afforded by the AD8676 allow maximum channel density or minimum board size for space-critical equipment.

The AD8676 is specified for the extended industrial temperature range (-40°C to $+125^\circ\text{C}$). The AD8676 is available in the 8-lead MSOP, and the popular 8-lead, narrow SOIC; both of which are lead-free packages. MSOP packaged devices are only available in tape and reel format.

For the single version of this ultraprecision rail-to-rail op amp, see the AD8675 data sheet.

PIN CONFIGURATIONS

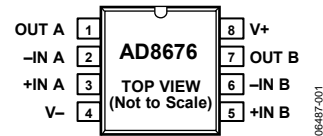

Figure 1. 8-Lead SOIC_N (R-8)



Figure 2. 8-Lead MSOP (RM-8)

Rev. 0

Information furnished by Analog Devices is believed to be accurate and reliable. However, no responsibility is assumed by Analog Devices for its use, nor for any infringements of patents or other rights of third parties that may result from its use. Specifications subject to change without notice. No license is granted by implication or otherwise under any patent or patent rights of Analog Devices. Trademarks and registered trademarks are the property of their respective owners.

TABLE OF CONTENTS

Features	1	Absolute Maximum Ratings	5
Applications.....	1	Thermal Resistance	5
Pin Configurations	1	Power Sequencing	5
General Description	1	ESD Caution.....	5
Revision History	2	Typical Performance Characteristics	6
Specifications.....	3	Outline Dimensions	10
Electrical Specifications.....	3	Ordering Guide	10

REVISION HISTORY

10/06—Revision 0: Initial Version

SPECIFICATIONS

ELECTRICAL SPECIFICATIONS

$V_S = \pm 5.0\text{ V}$, $V_{CM} = 0\text{ V}$, $V_O = 0\text{ V}$, $T_A = +25^\circ\text{C}$, unless otherwise specified.

Table 1.

Parameter	Symbol	Conditions	Min	Typ	Max	Unit
INPUT CHARACTERISTICS						
Offset Voltage	V_{OS}			12	50	μV
B Grade (SOIC)					60	μV
B Grade (MSOP)					100	μV
A Grade (SOIC, MSOP)						
Offset Voltage	V_{OS}	$-40^\circ\text{C} \leq T_A \leq +125^\circ\text{C}$		15	160	μV
B Grade (SOIC, MSOP)					250	μV
A Grade (SOIC, MSOP)						
Input Bias Current	I_B		-2	+0.5	+2	nA
		$-40^\circ\text{C} \leq T_A \leq +125^\circ\text{C}$	-5.5	+1	+5.5	nA
Input Offset Current	I_{OS}		-1	+0.1	+1	nA
		$-40^\circ\text{C} \leq T_A \leq +125^\circ\text{C}$	-2.8	+0.1	+2.8	nA
Input Voltage Range			-3.5		+3.5	V
Common-Mode Rejection Ratio	CMRR	$V_{CM} = -3.0\text{ V to }+3.0\text{ V}$	105	130		dB
		$-40^\circ\text{C} \leq T_A \leq +125^\circ\text{C}$	105	130		dB
Open-Loop Gain	A_{VO}	$R_L = 2\text{ k}\Omega$ to ground, $V_O = -3.5\text{ V to }+3.5\text{ V}$	1000	2000		V/mV
		$-40^\circ\text{C} \leq T_A \leq +125^\circ\text{C}$	700	1250		V/mV
Offset Voltage Drift	$\Delta V_{OS}/\Delta T$	$-40^\circ\text{C} \leq T_A \leq +125^\circ\text{C}$		0.2	0.6	$\mu\text{V}/^\circ\text{C}$
OUTPUT CHARACTERISTICS						
Output Voltage High	V_{OH}	$R_L = 2\text{ k}\Omega$ to ground $-40^\circ\text{C} \leq T_A \leq +125^\circ\text{C}$	+4.84 +4.78	+4.86 +4.82		V V
Output Voltage Low	V_{OL}	$R_L = 2\text{ k}\Omega$ to ground $-40^\circ\text{C} \leq T_A \leq +125^\circ\text{C}$		-4.95 -4.93	-4.86 -4.82	V V
Short-Circuit Limit	I_{SC}			+40		mA
Output Current	I_O			± 20		mA
POWER SUPPLY						
Power Supply Rejection Ratio	PSRR	$V_S = \pm 5.0\text{ V to } \pm 15.0\text{ V}$ $-40^\circ\text{C} \leq T_A \leq +125^\circ\text{C}$	106 106	120 120		dB dB
Supply Current/Amplifier	I_{SY}	$V_O = 0\text{ V}$ $-40^\circ\text{C} \leq T_A \leq +125^\circ\text{C}$		2.3 2.7	2.7 3.4	mA mA
DYNAMIC PERFORMANCE						
Slew Rate	SR	$R_L = 2\text{ k}\Omega$		2.5		V/ μs
Gain Bandwidth Product	GBP			10		MHz
NOISE PERFORMANCE						
Voltage Noise	$e_{n\text{ p-p}}$	0.1 Hz to 10 Hz		0.1		$\mu\text{V p-p}$
Voltage Noise Density	e_n	$f = 1\text{ kHz}$		2.8		nV/ $\sqrt{\text{Hz}}$
Current Noise Density	i_n	$f = 10\text{ Hz}$		0.3		pA/ $\sqrt{\text{Hz}}$

AD8676

$V_S = \pm 15\text{ V}$, $V_{CM} = 0\text{ V}$, $V_O = 0\text{ V}$, $T_A = +25^\circ\text{C}$, unless otherwise specified.

Table 2.

Parameter	Symbol	Conditions	Min	Typ	Max	Unit
INPUT CHARACTERISTICS						
Offset Voltage	V_{OS}			12	50	μV
B Grade (SOIC)					60	μV
B Grade (MSOP)					100	μV
Offset Voltage	V_{OS}	$-40^\circ\text{C} \leq T_A \leq +125^\circ\text{C}$		15	160	μV
B Grade (SOIC, MSOP)					250	μV
A Grade (SOIC, MSOP)						
Input Bias Current	I_B	$-40^\circ\text{C} \leq T_A \leq +125^\circ\text{C}$	-2	-0.5	+2	nA
			-4.5	-1	+4.5	nA
Input Offset Current	I_{OS}	$-40^\circ\text{C} \leq T_A \leq +125^\circ\text{C}$	-1	-0.1	+1	nA
			-2.8	-0.1	+2.8	nA
Input Voltage Range			-13.5		+13.5	V
Common-Mode Rejection Ratio	CMRR	$V_{CM} = -12.5\text{ V to } +12.5\text{ V}$ $-40^\circ\text{C} \leq T_A \leq +125^\circ\text{C}$	111	130		dB
			107	130		dB
Open-Loop Gain	A_{VO}	$R_L = 2\text{ k}\Omega$ to ground, $V_O = -13.5\text{ V to } +13.5\text{ V}$ $-40^\circ\text{C} \leq T_A \leq +125^\circ\text{C}$	1500	4000		V/mV
Offset Voltage Drift			$\Delta V_{OS}/\Delta T$	$-40^\circ\text{C} \leq T_A \leq +125^\circ\text{C}$	700	1700
				0.2	0.6	$\mu\text{V}/^\circ\text{C}$
OUTPUT CHARACTERISTICS						
Output Voltage High	V_{OH}	$R_L = 2\text{ k}\Omega$ to ground $-40^\circ\text{C} \leq T_A \leq +125^\circ\text{C}$	+14.65	+14.7		V
			+14.49	+14.59		V
Output Voltage Low	V_{OL}	$R_L = 2\text{ k}\Omega$ to ground $-40^\circ\text{C} \leq T_A \leq +125^\circ\text{C}$		-14.88	-14.75	V
				-14.83	-14.69	V
Short-Circuit Limit	I_{SC}			+40		mA
Output Current	I_O			± 20		mA
POWER SUPPLY						
Power Supply Rejection Ratio	PSRR	$V_S = \pm 5.0\text{ V to } \pm 15.0\text{ V}$ $-40^\circ\text{C} \leq T_A \leq +125^\circ\text{C}$	106	120		dB
			106	120		dB
Supply Current/Amplifier	I_{SY}	$V_O = 0\text{ V}$ $-40^\circ\text{C} \leq T_A \leq +125^\circ\text{C}$		2.5	2.9	mA
					2.9	3.8
DYNAMIC PERFORMANCE						
Slew Rate	SR	$R_L = 10\text{ k}\Omega$		2.5		V/ μs
Gain Bandwidth Product	GBP			10		MHz
NOISE PERFORMANCE						
Voltage Noise	$e_{n\text{ p-p}}$	0.1 Hz to 10 Hz		0.1		$\mu\text{V p-p}$
Voltage Noise Density	e_n	$f = 1\text{ kHz}$		2.8		nV/ $\sqrt{\text{Hz}}$
Current Noise Density	i_n	$f = 10\text{ Hz}$		0.3		pA/ $\sqrt{\text{Hz}}$

ABSOLUTE MAXIMUM RATINGS

Table 3.

Parameter	Rating
Supply Voltage	± 18 V
Input Voltage	$\pm V$ Supply – 1.5 V
Differential Input Voltage	± 0.7 V
Output Short-Circuit Duration to GND	Indefinite
Storage Temperature Range	
RM, R Packages	-65°C to $+150^{\circ}\text{C}$
Operating Temperature Range	-40°C to $+125^{\circ}\text{C}$
Junction Temperature Range	
RM, R Packages	-65°C to $+150^{\circ}\text{C}$
Lead Temperature Range (Soldering, 10 sec)	300°C

Stresses above those listed under Absolute Maximum Ratings may cause permanent damage to the device. This is a stress rating only; functional operation of the device at these or any other conditions above those indicated in the operational section of this specification is not implied. Exposure to absolute maximum rating conditions for extended periods may affect device reliability.

THERMAL RESISTANCE

Table 4. Thermal Resistance

Package Type	θ_{JA}	θ_{JC}	Unit
8-Lead MSOP (RM)	210	45	$^{\circ}\text{C}/\text{W}$
8-Lead SOIC_N (R)	158	43	$^{\circ}\text{C}/\text{W}$

POWER SEQUENCING

The op amp supplies must be established simultaneously with, or before, any input signals are applied.

If this is not possible, the input current must be limited to 10 mA.

ESD CAUTION



ESD (electrostatic discharge) sensitive device. Charged devices and circuit boards can discharge without detection. Although this product features patented or proprietary protection circuitry, damage may occur on devices subjected to high energy ESD. Therefore, proper ESD precautions should be taken to avoid performance degradation or loss of functionality.

TYPICAL PERFORMANCE CHARACTERISTICS

±15 V and ±5 V, $T_A = 25^\circ\text{C}$, unless otherwise specified.

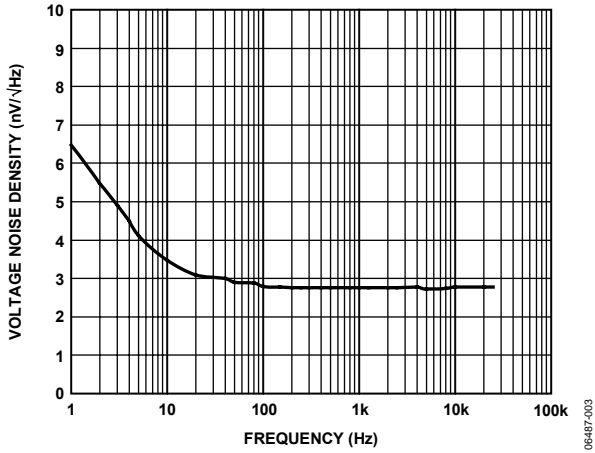

Figure 3. Voltage Noise Density vs. Frequency

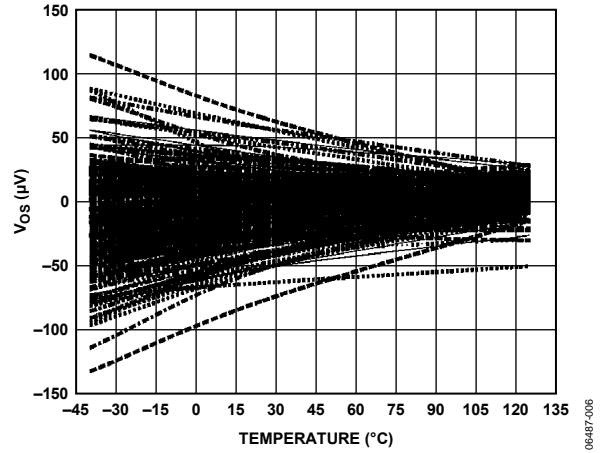

Figure 6. Offset Voltage vs. Temperature

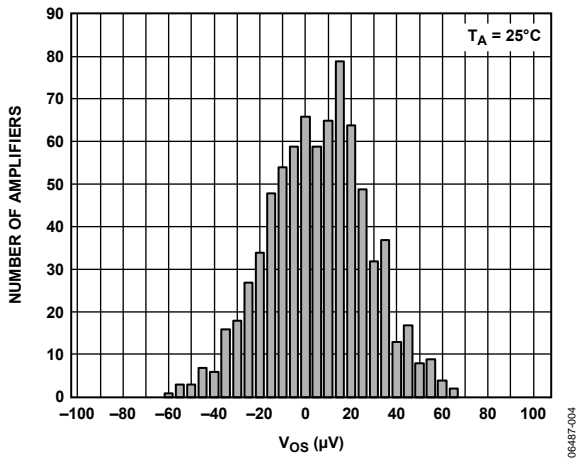

Figure 4. Input Offset Voltage Distribution

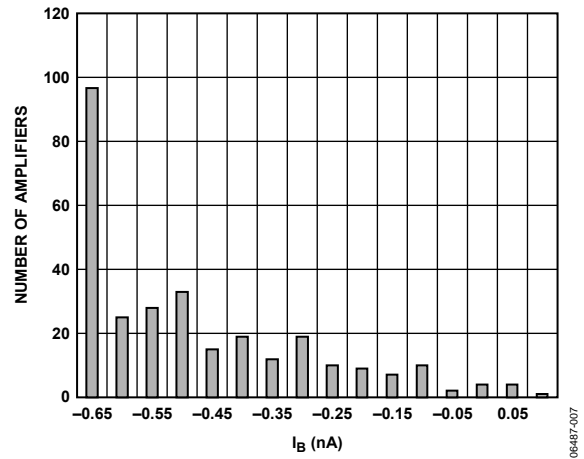

Figure 7. Input Bias Current, $V_{SY} = \pm 15\text{ V}$

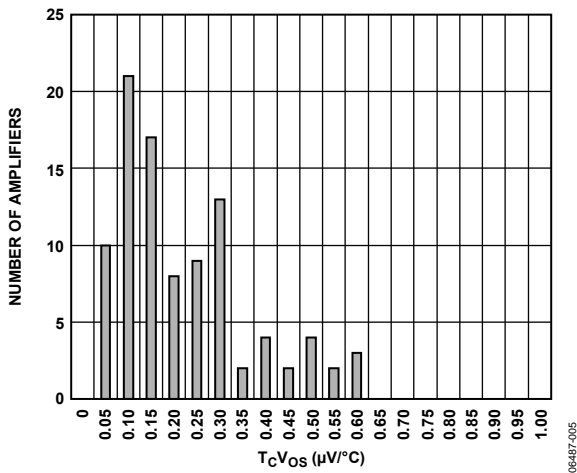

Figure 5. $T_c V_{OS}$ Distribution

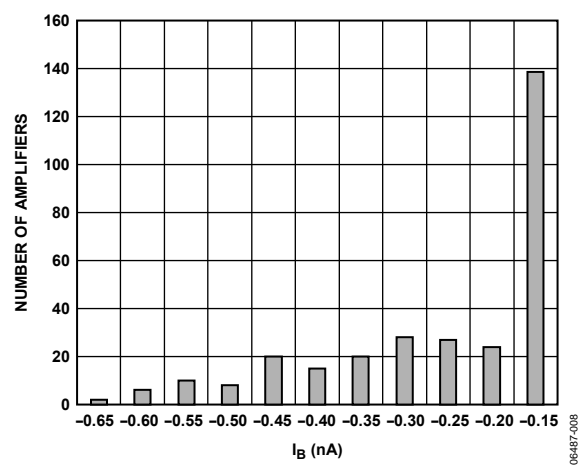

Figure 8. Input Bias Current, $V_{SY} = \pm 5\text{ V}$

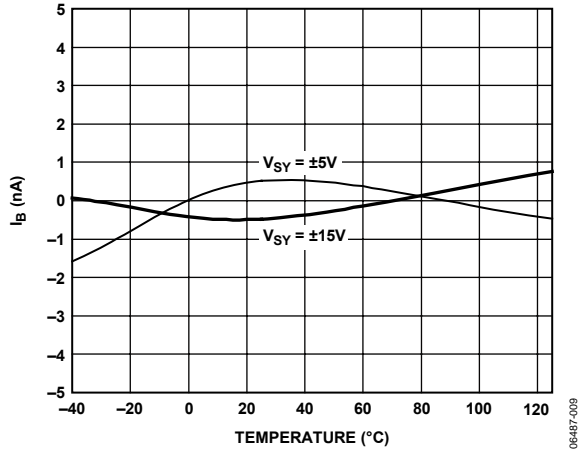

Figure 9. Input Bias Current vs. Temperature

06487-009

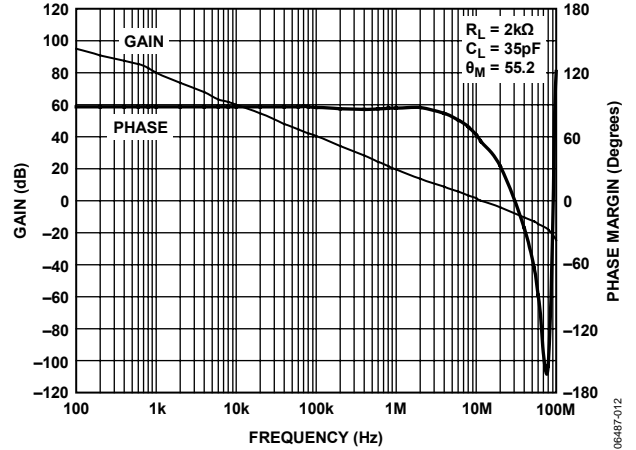

Figure 12. Gain and Phase vs. Frequency

06487-012

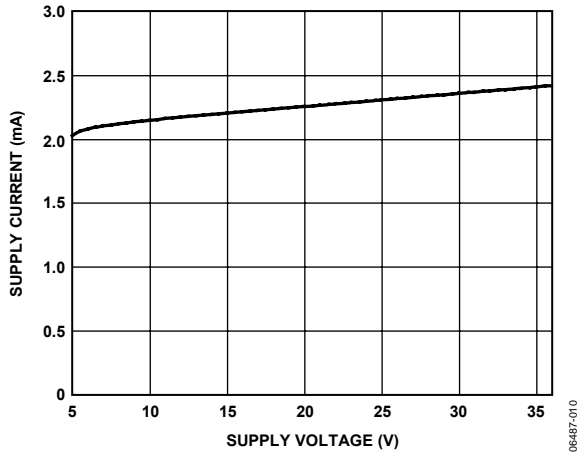

Figure 10. Supply Current vs. Total Supply Voltage

06487-010

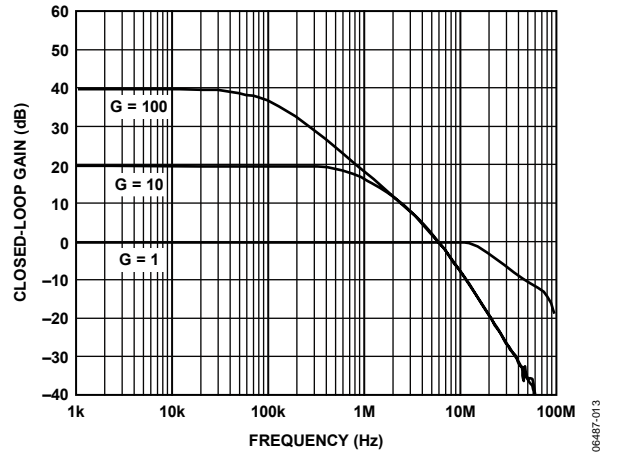

Figure 13. Closed-Loop Gain vs. Frequency

06487-013

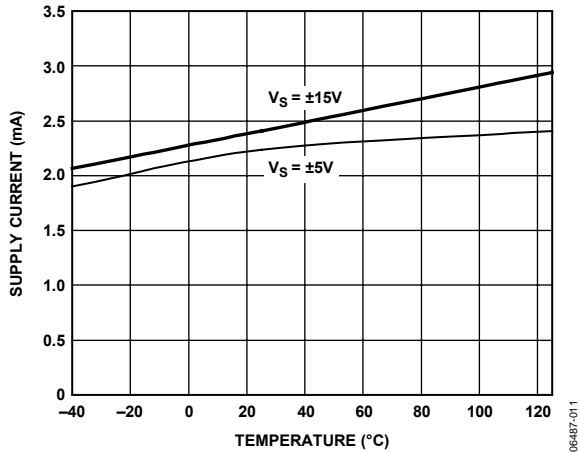

Figure 11. Supply Current vs. Temperature

06487-011

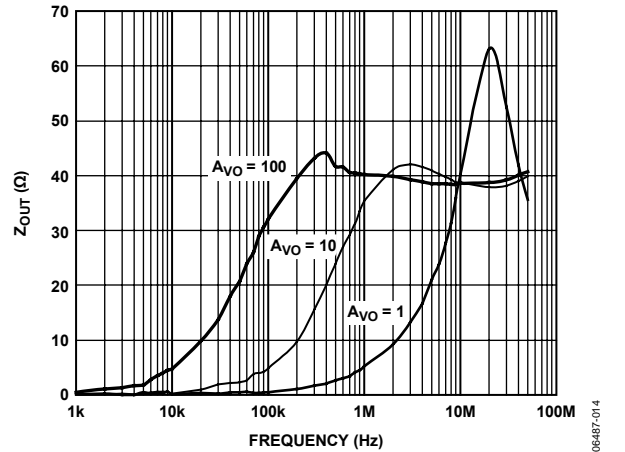

Figure 14. ZOUT vs. Frequency

06487-014

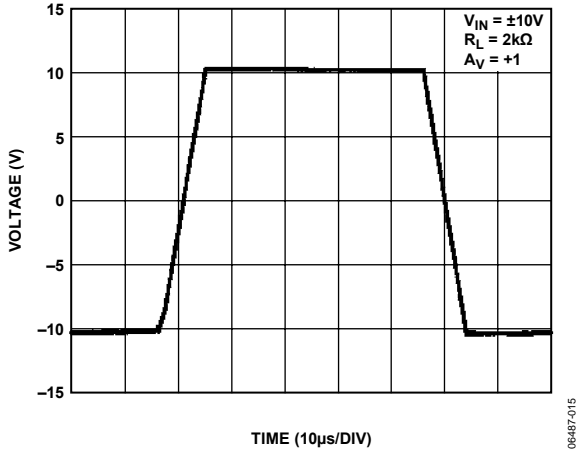

Figure 15. Large Signal Transient Response, $V_{SY} = \pm 15 V$

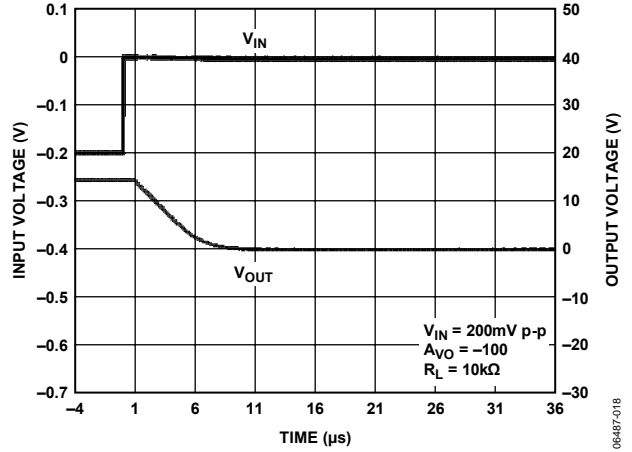

Figure 18. Positive Overvoltage Recovery

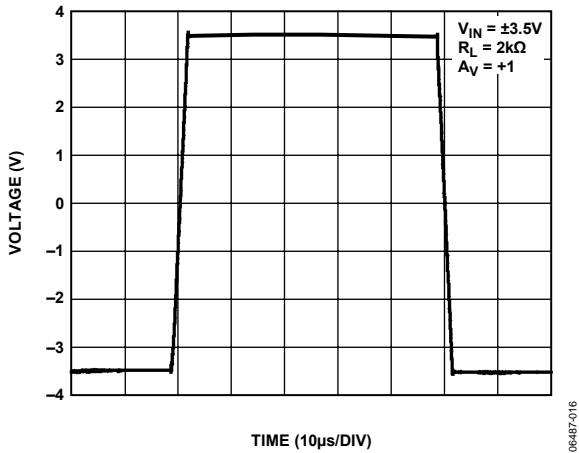

Figure 16. Large Signal Transient Response, $V_{SY} = \pm 5 V$

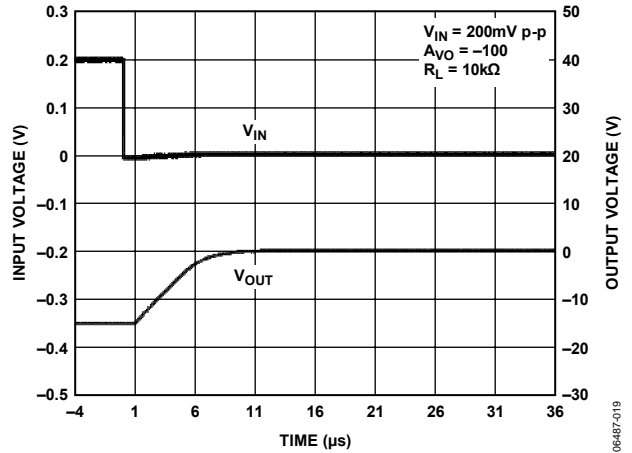

Figure 19. Negative Overvoltage Recovery

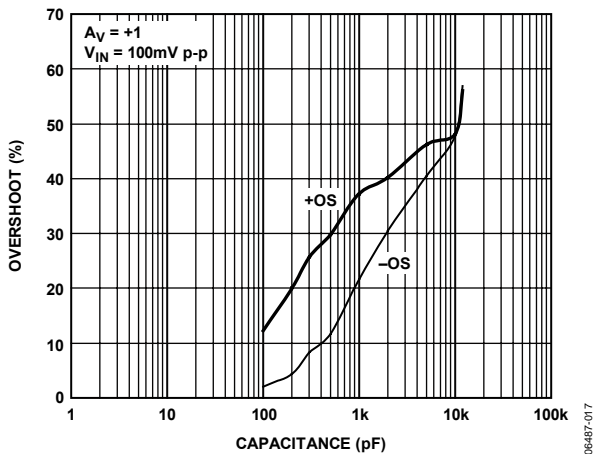

Figure 17. Small Signal Overshoot vs. Load Capacitance

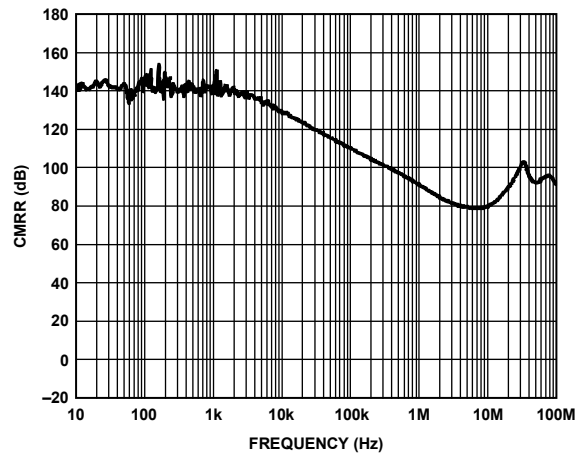

Figure 20. CMRR vs. Frequency

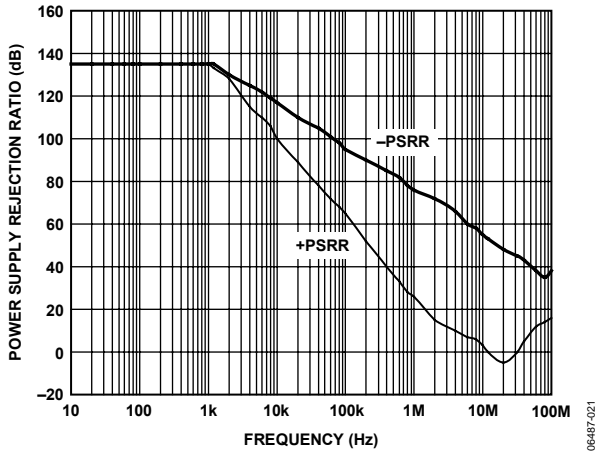

Figure 21. Power Supply Rejection Ratio vs. Frequency

06487-021

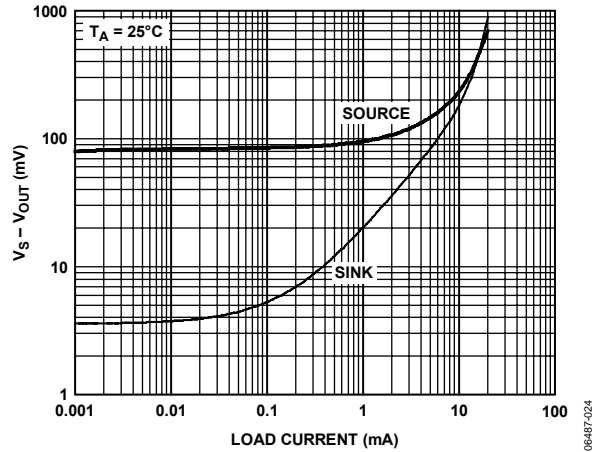

Figure 24. Output Saturation Voltage vs. Output Load Current

06487-024

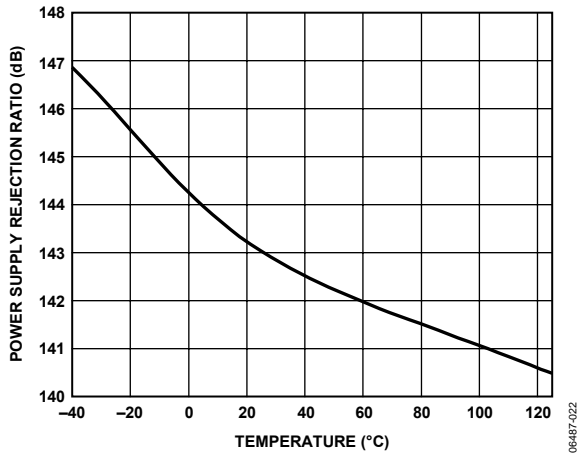

Figure 22. Power Supply Rejection Ratio vs. Temperature

06487-022

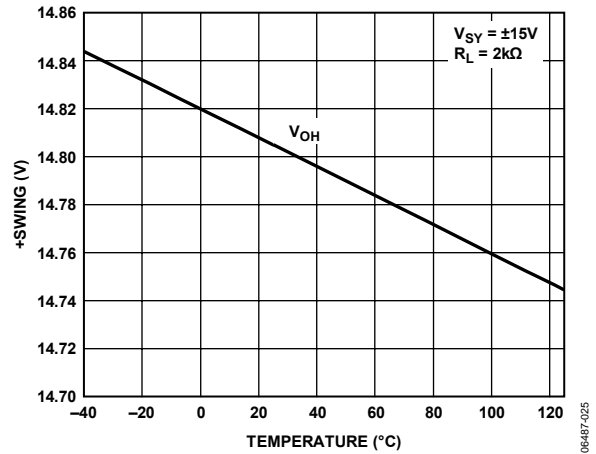

Figure 25. +Swing vs. Temperature, V_{OH}

06487-025

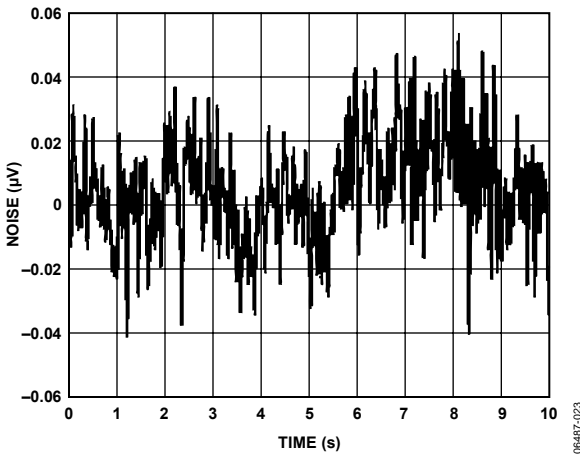

Figure 23. Voltage Noise (0.1 Hz to 10 Hz)

06487-023

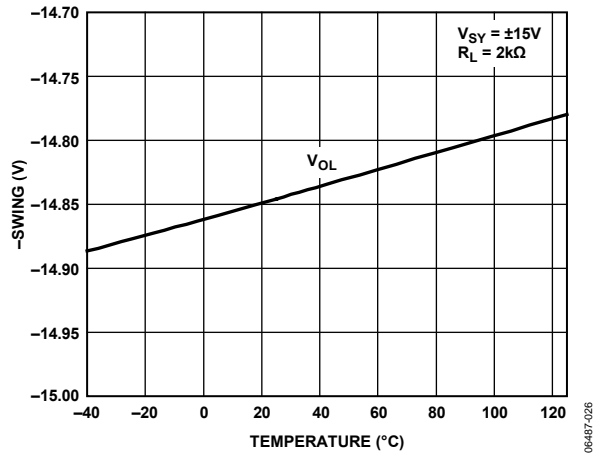
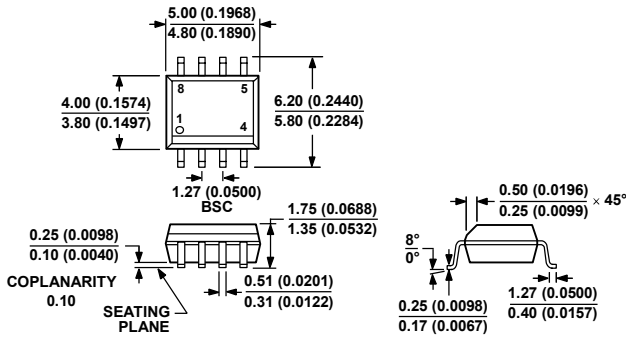

Figure 26. -Swing vs. Temperature, V_{OL}

06487-026

OUTLINE DIMENSIONS



COMPLIANT TO JEDEC STANDARDS MS-012-AA
CONTROLLING DIMENSIONS ARE IN MILLIMETERS; INCH DIMENSIONS
(IN PARENTHESES) ARE ROUNDED-OFF MILLIMETER EQUIVALENTS FOR
REFERENCE ONLY AND ARE NOT APPROPRIATE FOR USE IN DESIGN.

060306-A

Figure 27. 8-Lead Standard Small Outline Package [SOIC_N]
Narrow Body (R-8)
Dimensions shown in millimeters and (inches)

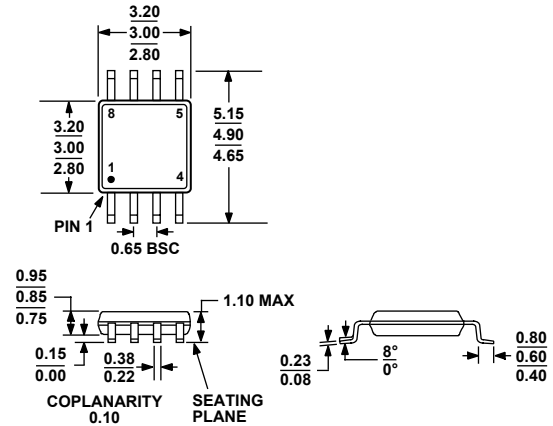

COMPLIANT TO JEDEC STANDARDS MO-187-AA

Figure 28. 8-Lead Mini Small Outline Package [MSOP]
(RM-8)
Dimensions shown in millimeters

ORDERING GUIDE

Model	Temperature Range	Package Description	Package Option	Branding
AD8676ARMZ-R2 ¹	-40°C to +125°C	8-Lead Mini Small Outline Package [MSOP]	RM-8	A13
AD8676ARMZ-REEL ¹	-40°C to +125°C	8-Lead Mini Small Outline Package [MSOP]	RM-8	A13
AD8676ARZ ¹	-40°C to +125°C	8-Lead Standard Small Outline Package [SOIC_N]	R-8	
AD8676ARZ-REEL ¹	-40°C to +125°C	8-Lead Standard Small Outline Package [SOIC_N]	R-8	
AD8676ARZ-REEL7 ¹	-40°C to +125°C	8-Lead Standard Small Outline Package [SOIC_N]	R-8	
AD8676BRMZ-R2 ¹	-40°C to +125°C	8-Lead Mini Small Outline Package [MSOP]	RM-8	A1L
AD8676BRMZ-REEL ¹	-40°C to +125°C	8-Lead Mini Small Outline Package [MSOP]	RM-8	A1L
AD8676BRZ ¹	-40°C to +125°C	8-Lead Standard Small Outline Package [SOIC_N]	R-8	
AD8676BRZ-REEL ¹	-40°C to +125°C	8-Lead Standard Small Outline Package [SOIC_N]	R-8	
AD8676BRZ-REEL7 ¹	-40°C to +125°C	8-Lead Standard Small Outline Package [SOIC_N]	R-8	

¹ Z = Pb-free part.

NOTES

AD8676

NOTES